



Portable Evaporative Cooler

**WayCool® 1/3HP A Series
USER'S MANUAL**



SCHAEFER
Ventilation Equipment

Using this equipment for any other purpose than it was intended or in a way not within the operating recommendations specified in this manual will void the warranty and may cause personal injury.

This manual is designed to provide comprehensive planning, installation, safety, operation, maintenance, troubleshooting and parts information. If a problem should arise, or if replacement parts are needed, your Schaefer dealer can supply the necessary information to help you. Call Schaefer Ventilation Equipment at 800-779-3267 to locate a dealer.

Table of Contents

INTRODUCTION	3
Why use evaporative coolers in your workplace	3
How evaporative cooling works	3
ABOUT THIS MANUAL	4
SAFETY INFORMATION.....	4
SAFETY RECOMMENDATIONS	5
SPECIFICATIONS	5
DESCRIPTION	6
WATER SUPPLY SYSTEM	7
COOLING PAD ASSEMBLY	9
BLOWER AND DUCTWORK	10
CONTROL	11
OPERATION AND MAINTENANCE	11
Unit placement and other considerations	11
Unpacking and initial setup	12
Regular cleaning	13
Normal startup	13
Normal shutdown	13
TROUBLESHOOTING	14
Cooling pads not wetting	14
Foaming	14
Line clogs or obstructions	14
Odor Control	14
Scale Buildup.....	14
Splattering in front	14
Leaking from the bottom	14
OPTIONS AND ACCESSORIES.....	15
Pneumatic wheels	15
Water conditioner and cleaner.....	15
Aluminum grates	15
Oscillating spout	16
WARRANTY	17

WHY USE EVAPORATIVE COOLERS IN YOUR WORKPLACE

- The WayCool® evaporative cooler requires little space, has a low initial cost, is inexpensive and simple to operate and requires minimal scheduled maintenance.
- Due to the design and construction of the cooling pads, cooling efficiency is normally maintained near optimum throughout the life of the pads (approximately two seasons).
- In many cases, evaporative coolers are a better solution than mechanical refrigeration systems because they are more economical to operate and maintain, and do not use environmentally sensitive and costly refrigerants.

HOW EVAPORATIVE COOLING WORKS

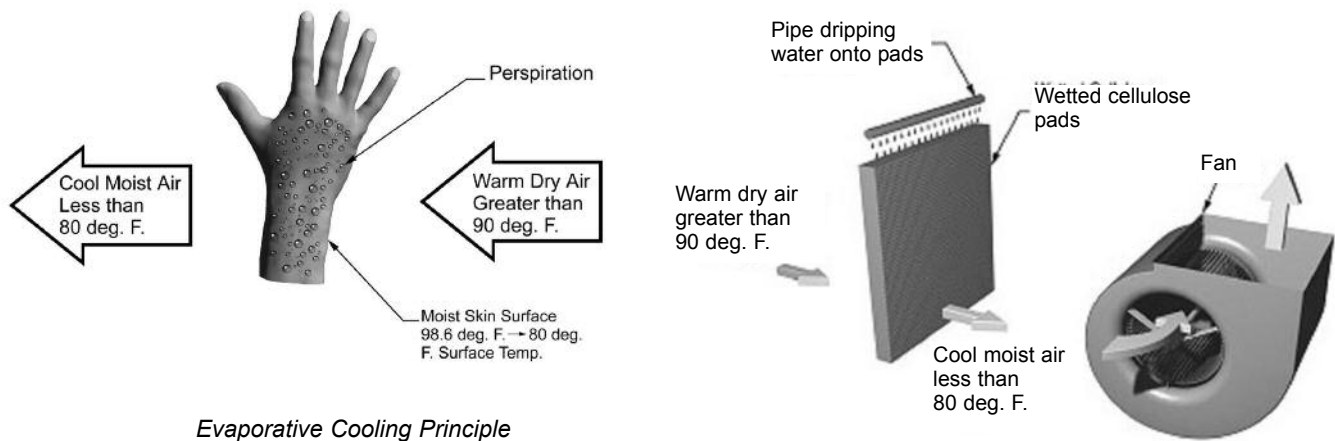

Evaporative cooling is the same process your body uses to cool itself. When you perspire, and air moves across your skin, a portion of the perspiration (water) evaporates. Evaporation requires heat to change liquid water to water vapor and this heat is taken from your skin, producing the cooling effect.

In an evaporative cooler, the cellulose cooling pads take the place of your skin, water instead of perspiration wets them and a fan moves the air. The air blows across the cooling pads and evaporates moisture. Heat is drawn from the pads and the air, dropping the air temperature and producing the cooling effect. The cooled air is then forced through a building or space and displaces the warm air out of building openings, cooling the surroundings. In addition, air velocity increases the cooling effect as it moves over the skin of people in the airflow path.

WayCool® evaporative coolers are portable and use the latest technology to provide large volumes of cool air, efficiently and inexpensively, for cooling small to medium size areas. Simply add more units to accommodate larger areas. With proper sizing and application, a WayCool® portable evaporative cooler can lower the effective air temperature by up to 20 degrees F. Even in high humidity, the efficiency of the WayCool® evaporative cooler provides effective cooling.

About This Manual

The intent of this manual is to help you in two ways: to provide you with step-by-step instructions for quick and easy assembly of your product, and to serve as a reference for simple maintenance and questions you may have regarding your product.

Read ALL instructions carefully before starting your WayCool®. Pay particular attention to all SAFETY information.

Optional equipment contains necessary instructions for assembly and/or operation.

The WayCool® Evaporative Cooler is labeled with a serial number. The serial number is located inside the unit on the aluminum frame, behind the switch. Removal of the serial number label will void all warranties.

All information, illustrations and specifications in this manual are based on the latest product information available at the time of printing. Product specifications subject to change. We reserve the right to make changes at any time without notice.

Safety Information

Warning and Danger Decals have been placed on the equipment to warn of potentially dangerous situations. Care should be taken to keep this information intact and easy to read at all times. Replace missing or damaged safety decals immediately. The diagram below shows the proper location of the safety decals as shipped from the factory.



Start Unit -Turn water pump on 5-10 minutes before running blower to wet evaporative cooling pads.

Shut Down -Turn pump off and run only blower until evaporative cooling pads are dry. This prolongs the life of the pads.

WARRANTY- VOID IF YOU RUN THE PUMP WITHOUT WATER.

CAUTION - ALWAYS TURN OFF AT SWITCH AND DISCONNECT POWER BEFORE REMOVING EVAPORATIVE COOLING PADS FOR CLEANING OR INTERNAL MAINTENANCE.

CLEANING- Clean pads a minimum of once every two weeks. Remove pads from unit and clean with garden hose only. DO NOT use chemicals or high pressure hose.

WARNING!

Interference with the oscillating spout while the unit is operating, or manually directing the oscillating spout, will cause damage to the gear motor. Keep oscillating path clear of obstructions.

This warning decal is found on the top of oscillating units only.

Using the equipment for purposes other than specified in this manual may cause personal injury and/or damage to the equipment.

Safety Alert Symbol



This is a safety alert symbol. When you see this symbol on your equipment, be alert to the potential for personal injury. This equipment is designed to be installed and operated as safely as possible; however, hazards do exist.

Signal Words are used in conjunction with the safety alert symbol to identify the severity of the warning.

CAUTION indicates an imminently hazardous situation, which, if not avoided, COULD cause damage to your equipment or equipment failure.

WARNING indicates a potentially hazardous situation, which, if not avoided, COULD result in death or serious injury.

Safety Recommendations

READ AND SAVE THESE INSTRUCTIONS!



This is an electric device with moving components. There is the possibility of fire, electric shock or injury to persons. Ensure all the safety recommendations are adhered to in order to minimize this risk.

- Disconnect all power and unplug the unit before you inspect, clean or perform maintenance on the components of the unit.
- Never reach into the unit when it is running; you could become entrapped by the V-belt or injured by the rotating fan blades.
- The metal frame edges are sharp; don't run your hand along them. Be careful and wear gloves when you reach under the frame to inspect the PVC pipes and mesh socks.
- A GFCI (Ground Fault Circuit Interrupter) is recommended for use with this product.
- If pads and grates are removed for servicing, they must be replaced prior to operating the unit.

PLEASE NOTE



- Minimum inlet pressure is 10 PSI; maximum inlet pressure is 100 PSI.
- Never leave unit unattended while in operation.

Specifications

- **Height and Width** 25" x 25" wide x 44" high (with casters and directional spout)
- **Shipping Weight** 135 pounds
- **Blower** double-inlet centrifugal
- **Motor** 1/3 HP, 115V, 2 speed, 60 Hz (also available in 230V and 50 Hz)
- **Pump Filter** washable polyethylene filter
- **Pump Discharge Filter** 480 micron stainless steel
- **Reservoir Capacity** 14 gallons
- **Pump** submersible, vane type, 210 gallons per hour
- **Housing** high impact ABS plastic with UV protection
- **Evaporation Media** chemically treated cellulose paper
- **Optional Water Supply** standard 3/4" hose connection (garden hose size)

Actual WayCool® varies slightly from unit shown here.

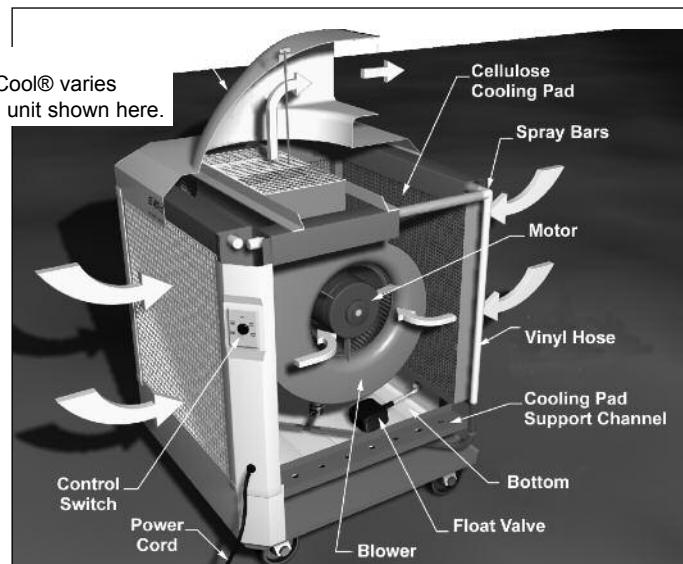

Component Overview

Description

The WayCool® evaporative cooler is a completely self-contained, portable unit capable of delivering 25.5 MPH velocity of air with a temperature drop of up to 20 degrees F. The unit is composed of:

- Level-controlled water supply system
- Cooling pad assembly
- Motor-driven blower and ductwork
- Controls
- Frame and housing

The reservoir is made of high impact ABS plastic and holds approximately 14 gallons at normal operating level (about 4" deep).

A float-operated valve automatically maintains proper water level when the unit is connected to a water supply.

The reservoir rests on, and is fixed to, an aluminum cradle. The reservoir, in turn, is secured to the aluminum frame. Four casters (two locking, two non-locking) are attached to the underside of the aluminum cradle.

A pump draws water from the reservoir and discharges it through the vinyl hose to the PVC pipes located above the cooling pads. The PVC pipes distribute water onto the top of the cooling pads; saturating them. Excess water drips back into the reservoir through the holes in the cooling pad support channels.

The cellulose cooling pads sit in support channels and are held in place by plastic retaining grates. The grates also help prevent damage to the cooling pads. Two pad sections fit in each side of the unit (total eight sections) to totally enclose the unit.

The blower is hung from the top of the frame and powered by a direct-drive 1/3HP electric motor. The blower draws room air through the cooling pads where it picks up moisture and cools by evaporation. The blower then discharges the cooled air through the spout.

It is important the cooled space has sufficient air openings so the warmer air can flow out and be replaced by the cooled air. A closed-in space or high humidity will reduce the cooling effect. See Unit Placement and Other Considerations in the "Operation and Maintenance" section of this manual.

A screen covers the discharge duct to prevent foreign objects from entering the blower. A threaded rod screws through a threaded brace above the screen to hold the spout in position. A plastic knob secures the spout to the rod. The spout is made of a tough, durable plastic and can be manually rotated 360 degrees to provide cool air in any direction without moving the unit.

Water weighs about eight pounds per gallon, so when the unit is full it weighs over 240 pounds. During setup and before startup, place the unit in the desired location and then fill the reservoir. Do not attempt to lift the unit once it is filled and be careful to avoid spills when moving it, even over smooth ground. Do not try to push it over rough or soft ground as you can overstress the wheels and frame and cause structural and component damage, which is not covered by warranty.

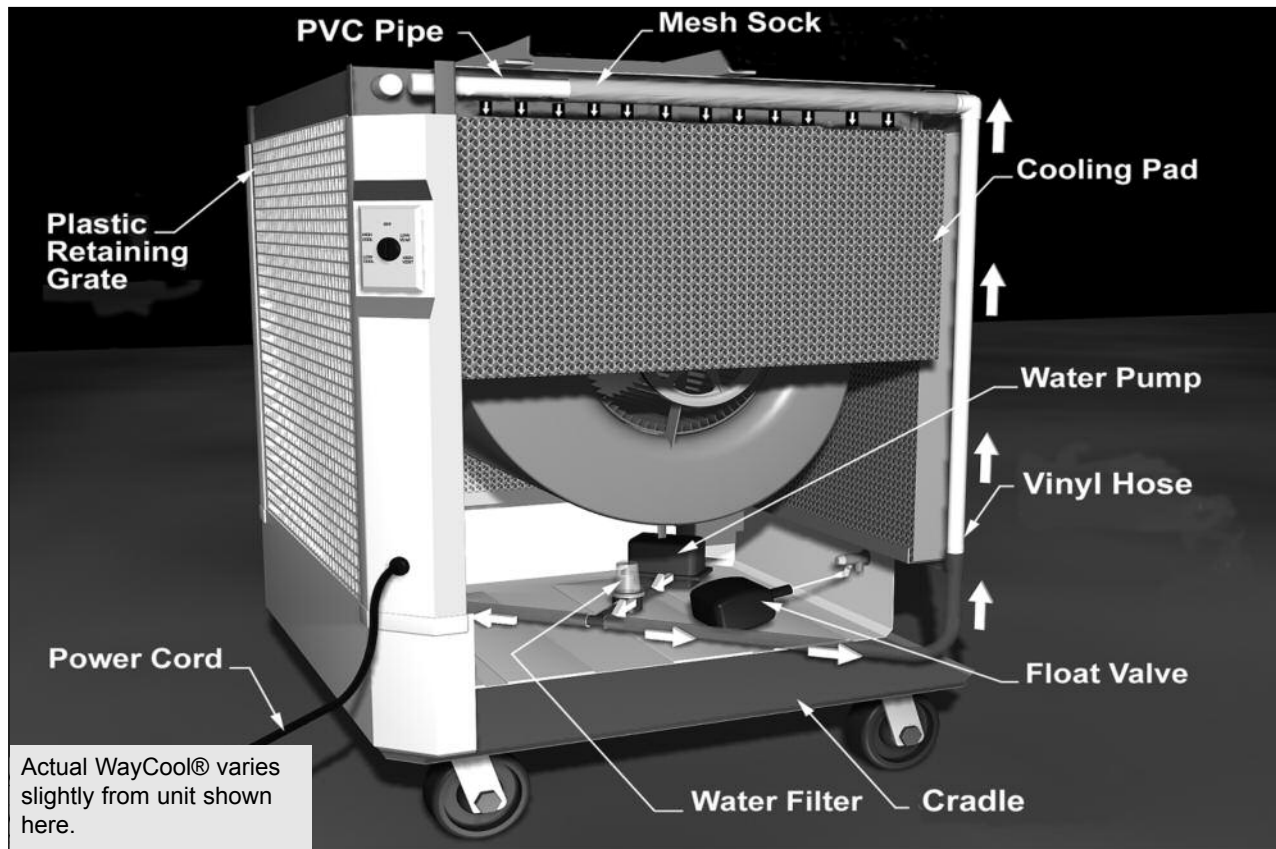

Water Supply System

The reservoir can be supplied continuously with an ordinary garden hose by attaching the supplied hose adapter to the fill connection, or it can be filled manually.

With a continuous water supply connected, the float valve in the reservoir (like the one in your toilet tank) rises and falls with the water level. A linkage attaches the float to the shutoff valve in the fill connection. As the water level rises to normal operating level (about 3" deep), the float valve shuts off the water supply. When the water level drops, the float valve reopens to maintain a normal operating level.

After unplugging the unit, the reservoir can also be manually filled with a hose or bucket, if a hose connection is impractical. Simply remove any of the plastic retaining grates and one of the cooling pad sections and place the hose, or pour the water, directly into the reservoir. When you fill the reservoir manually it can be filled to a higher level, but make sure someone monitors the filling operation to avoid overfilling and flooding.

Water damage due to overfilling is not covered by the warranty.

When you run the unit and fill it manually, check the water level frequently so it does not run dry. The automatic shut-off feature is intended to prevent operation of the pump without water, which can damage it or reduce its service life. The cooling effect also stops if the pads dry.

Pads and grates must be replaced before operating unit.

Water Supply System cont'd

A drain in the reservoir allows you to drain the unit for cleaning and maintenance. A drain cap on the underside of the aluminum tray covers the drain during operation. Make sure the cap is in place before you fill the reservoir. The drain cap should be finger-tightened only.

The pump is attached to a bracket, which in turn is fixed to the blower housing. The bracket holds the pump in its proper position on top of the foam filter and slightly above the bottom, allowing sufficient space for water to enter the pump suction.

The pump can be easily removed and replaced with the services of a qualified electrician.

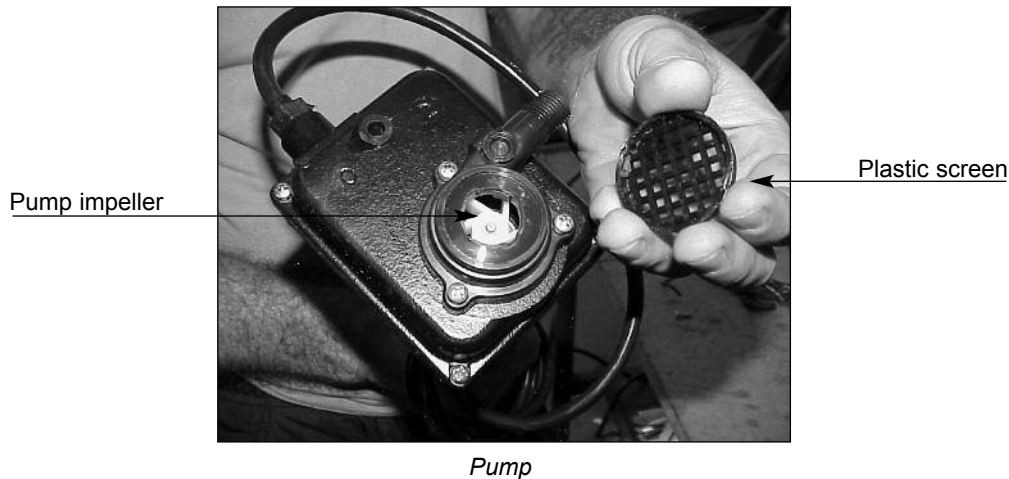

A small plastic screen covers the pump inlet to prevent foreign matter from entering and damaging the pump impeller. The screen snaps in place and can be easily removed for inspection or cleaning.

The pump sits on a foam filter; somewhat like a sponge. The filter traps dirt that could enter the water distribution system and build up on the cooling pads, reducing their effectiveness. Dirt could also accumulate in the PVC pipes and plug up the spray holes.

The pump discharges through a fine screen washable filter which decreases the contamination of the cooling pads and water system. The discharge filter casing is a clear plastic so dirt buildup on the internal screen is easily visible. As dirt builds up, water flow to the cooling pads is reduced and performance decreases. The clear filter housing is threaded and screws into the filter body for easy removal to access the screen.

A dirty water supply will quickly reduce the unit's performance and the unit will require more frequent cleaning to maintain cooling effectiveness. Always try to use a filtered, treated water supply.

A clear vinyl hose connects the pump to the filter. From the filter, a "T" connector supplies two lines that run along the bottom and up opposite frame corners to supply the PVC pipe with water. Each vinyl hose connects to two PVC pipes which run horizontally along the top of the frame above the cooling pads.

The PVC pipes have a series of holes that run the full length of the pipe. Each PVC pipe is covered with a plastic mesh sock which helps break up the water as it leaves the spray holes. This gives a more even water distribution across the cooling pad and reduces splashing. The holes direct the water inward at a 90° angle to continuously saturate the cooling pads from the top down. Excess water drains back to the reservoir through drainage holes in the bottom support channels which support the cooling pads.

Water cleanliness has a major effect on the cooler's performance. Use a clean water supply and consider a water softener if your water is hard. Dissolved solids in hard water deposit on the cooling pad surfaces and reduce the airflow through the unit and therefore the amount of evaporation.

The cooling pads are critical for proper, efficient cooler operation. They are made of laminated cellulose (paper) fibers and arranged to give a large surface area for evaporation and to provide a rigid structure. The shape of the cells allows high velocity airflow through the pad at a minimum pressure drop. At the same time, the air passages between the cells force the incoming air to impinge on the wet cell surfaces and maximize evaporation.

The WayCool® evaporative cooler also acts as an air filter and removes dust and other particles from the air. This dirt collects on the cooling pads and lowers cooler efficiency. The pads should be cleaned at least weekly and more frequently in dusty conditions. See Regular Cleaning under "Operation and Maintenance."

The pump supplies a continuous flow of water over the pads causing a "sheet flow" which constantly replaces the water lost to evaporation and keeps the pads saturated.

One cubic foot of the cooling pad material holds about a gallon of water during operation. One cubic meter holds about 100 liters of water.

The cooling pads are relatively strong but are subject to crushing, especially when wet. Always run the unit with the plastic retaining grates in place and handle them carefully when you clean them. Crushed cells reduce the total airflow through the unit and therefore lowers its cooling capacity.

The cooling pad sections (two sections per side, eight sections total) are held by metal channels at the top and bottom of the unit. The channels hold the cooling pads in position and form four sidewalls to completely enclose the unit.

The top channels house the PVC pipe, which run horizontally along the channel directly above the cooling pads. The bottom channels have a series of holes drilled through them to allow excess water flowing down the cooling pads to return to the reservoir.

The plastic retaining grates fit in front of the cooling pads and sit in the same channels as the pads; holding them in place and protecting them from accidental damage. The plastic grates and cooling pads are easily removed by placing a flat blade under the bottom and lifting upwards, then outwards. Once one pad is removed, the others can be lifted up and out by hand without using a blade.

Do not remove or handle the cooling pads when they are wet, as they damage easily. Run the blower without the pump until pads are dry. With normal care, the pads should last at least two seasons. Abuse or mishandling will reduce their effectiveness and shorten their life.

Blower and Ductwork

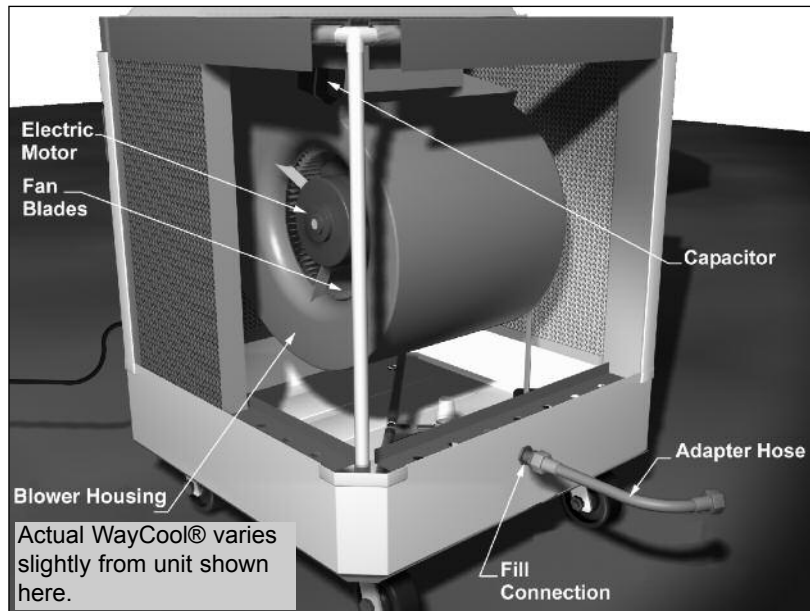

Fan Blower

The WayCool® uses a direct-drive, 1/3 HP electric motor to drive a centrifugal blower. The blower draws room air through the cooling pads and discharges the cooler air through the spout, displacing the warmer air with cooler air and decreasing the temperature.

The blower is secured to the top of the frame and hangs upside down to direct the air out the top of the unit. Brackets on each side of the blower casing secure the blower to the frame and hold it in position.

The electric motor is secured to the blower casing by metal braces and connects directly to the blower shaft. A startup capacitor is attached to the top of the blower casing and is wired to the motor.

A capacitor retains electrical energy even after the unit is shut down and unplugged. DO NOT TOUCH the bare connections or you could be injured.

The power cord runs down the frame leg that has the control switch on the outside. It exits the frame leg at the bottom and has a male plug that must be plugged into a suitable GFCI-protected receptacle. The cord is approximately nine feet long.

The standard unit requires 120 volts and 7 amps of power. This is normally available on most circuits. However, if you are running a number of other items on the same circuit, you may trip the breaker. If so, plug the WayCool® into another circuit. If you require an extension cord, make sure it is at least #14 wire and no longer than 50 feet. If you need a longer cord, use one with #12 wire. Using smaller wire or a longer cord will degrade performance, shorten the life of the electric motor and could cause a fire. None of this is covered by warranty.

The WayCool® control switch is mounted on the outside of one frame leg.

It has the following positions:

OFF power is off to the blower motor and the pump motor.

LOW VENT the blower runs at low speed and the pump is OFF.

HIGH VENT The blower runs at high speed and the pump is OFF. Use this setting to quickly dry the cooling pads for removal and cleaning.

LOW COOL the blower runs at low speed and the pump is on. Use this setting for low cooling loads.

HIGH COOL the blower runs at high speed and the pump is on. Use this setting for maximum cooling.

PUMP ONLY pump is on and the blower is off. Use this setting during startup to first saturate the cooling pads, then switch to LOW COOL or HIGH COOL to begin cooling.



Control Switch

Operation and Maintenance

UNIT PLACEMENT AND OTHER CONSIDERATIONS

The WayCool® should be placed at one end of the building and an appropriate exhaust fan should be at the opposite end to pull the cool air from the WayCool® and discharge the warm air out of the building.

Try to get all the air flowing in the same direction. Do not direct other fans against the WayCool® as they will counter the airflow and hinder the cooling effect.

Obstructing the airflow from the WayCool® severely reduces the cooling effect.

Avoid using ceiling fans as they disrupt the airflow from the WayCool®.

Use as many exhaust fans as possible to create a natural draft through the building. This will enhance the performance of the WayCool®.

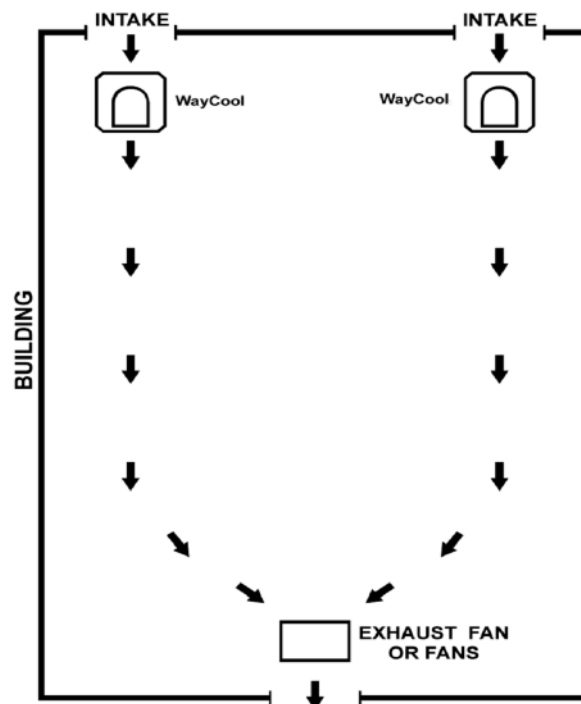

Typical Arrangement

Operation and Maintenance cont'd

UNPACKING AND INITIAL SETUP

The WayCool® is shipped upright in a corrugated container. The unit is fully assembled and ready for service except for thoroughly cleaning manufacturing dust from the cooling pads before running it for the first time.



CAUTION Be careful when you move the unit while it is in the shipping container and when moving it around with the container removed. Avoid jarring or dropping the unit.

1. With the unit in the upright position as marked on the container, use a sharp knife or scissors to cut the straps that wrap the shipping container.

Do not discard the container until you have thoroughly inspected the unit.

2. Remove the shipping container.
3. Ensure the switch is OFF and the unit is unplugged.
4. Remove the plastic retaining grates from all four sides of the unit. Use your fingers to lift each upward, then outward from the bottom.
5. Remove the cooling pads from all four sides of the unit. Place a putty knife or large flat-blade screwdriver under the pad to lift it up, then outward. With one pad out, the rest can be easily removed by placing one hand on the pad's inside, your other hand on the outside and lifting the pad up and out from the bottom.
6. Inspect the entire unit for shipping damage.
7. Look for cracks in the bottom near the frame legs. This is also an indication of rough handling.
8. Ensure the frame legs are straight and in alignment, and that the blower is sitting level and in proper position.

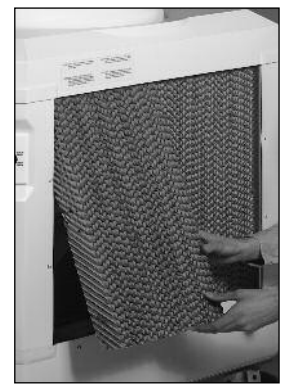

Pads

If you notice any damage to your unit, immediately contact the dealer where it was purchased.

9. Thoroughly clean all eight cooling pad sections using a garden hose.

Do not use cleaning fluids or other chemicals to clean the pads as they can cause foaming during operation. Use only clean water. Refer to page 15 for approved cleaners.

10. Remove the drain cap from the underside of the reservoir and rinse with a hose to flush any manufacturing dust etc. from the unit. Replace the drain cap.
11. Replace the pads and the protective retaining grates.
12. Proceed to **NORMAL STARTUP**.

REGULAR CLEANING

The frequency with which the WayCool® should be cleaned will depend on the environment in which it is used. The more dirty the environment the more often it will need cleaning. ***In most cases the WayCool® will need to be cleaned weekly.***



CAUTION The pads should be dry before you handle them, as they are stronger when dry than when they are wet and less susceptible to damage. If they are wet, run the unit in the HIGH VENT position until they are dry. After cleaning, let the pads air dry before you replace them.

1. Turn the switch to OFF and unplug the unit.
2. Remove the plastic retaining grates and check the pads for cleanliness. If they are dirty, remove and clean by spraying with a garden hose (water only). If they are not dirty you will still need to remove the cooling pads to clean the inside of the unit. Dirty cooling pads reduce the unit's effectiveness.
3. Use a garden hose to rinse out the bottom and the inside of the unit. The dirt that accumulates is removed from the air during operation, as the WayCool® also acts as an air filter.
4. Remove the drain cap from the underside of the unit and let it unit drain completely. Rinse out any remaining dirt.
5. Replace the drain cap (finger tighten only).
6. Remove the pump discharge filter by unscrewing the top, removing the screen and rinsing it with a hose or under a tap. Replace the filter screen and screw the top back on.
7. Remove the pump filter from underneath the pump. Wash thoroughly with a hose. Compress filter and place back under the pump.
8. Replace the cooling pads once they are dry and re-install the plastic retaining grates.

With proper use and regular cleaning, the cooling pads will last about two seasons. If you handle them wet and are abusive, however, they will be easily damaged. Refer to page 15 for recommended conditioning and cleaning chemicals.

NORMAL STARTUP

1. Place the unit where it will be run. Do not attempt to lift or move the unit once it is filled. Damage to the unit or a large spill may occur.

When you decide where to place the unit, make sure there are no obstructions that could disrupt or block the airflow. Make sure the unit is level at all times. Keep the unit at least three feet away from walls or other obstructions that will interfere with airflow into the unit.

2. Check the drain cap to be sure it is in place and secure.
3. Connect the garden hose to the brass hose adapter. Be sure there is a washer in the female end of the hose connection.
4. Open the water supply valve and be sure water enters the reservoir through the float valve by removing one cooling pad on the side with the water connection. Allow the unit to fill and be sure the float valve shuts off the water completely.
5. If you are filling the unit manually, remove one or more cooling pads and fill the reservoir with a bucket or hose.
6. Monitor the filling operation to avoid overflowing and damage.
7. Plug the unit into a GFCI protected outlet.
8. Adjust the spout to discharge cool air in the desired direction and tighten the knob on the end of the threaded rod.
9. Turn the switch to the PUMP ONLY position and let it run for five to 10 minutes to saturate the cooling pads. Check that the pads are saturated completely and there are no dry spots.



CAUTION Do not run the pump without water in the reservoir. The automatic shut-off feature is intended to prevent operation of the pump without water, which can damage it or reduce its service life. Running the pump dry will void the warranty on the pump. The red light indicates low water level (pump is off).

10. Turn the switch to the HIGH COOL or the LOW COOL position to begin normal cooling operation.

NORMAL SHUTDOWN

1. Turn the switch to the HIGH VENT position and let the unit run until the cooling pads are dry. This will maximize the life of the pads.
2. Turn the switch to the OFF position. Unplug the unit if you are going to clean the pads or inspect the components.
3. Shut off the water supply.
4. Drain the reservoir if you are going to clean or store the unit.
5. If the unit will be stored for the season, ensure the cooling pads are completely dry, and then remove them. Wrap them in plastic bags or store them in a clean place where they will not be damaged or get dirty. The unit should be cleaned thoroughly before storing.

Troubleshooting

COOLING PADS NOT WETTING

1. Ensure there is water in the reservoir.
2. Ensure the motor switch is in the START position and the pump switch is in the ON position.
3. Ensure the pump is running.
4. *Pump is running but no water:*
 - a. Ensure hose is connected.
 - b. Inspect and clean the pump discharge filter.
 - c. Inspect and clean the pump intake filter.
 - d. Ensure the impeller on the inside of the pump turns freely.
5. *Pump is not running:*
 - a. A certified electrician must check the wiring from pump to pump selector switch.
 - b. If the wiring is correct, replace the pump.

FOAMING

Foaming is generally caused by a dirty water supply or contaminated water in the reservoir.

1. If foaming occurs, stop the unit, drain it and flush the bottom and inside thoroughly with clean water.
2. Clean the pads and do not use any kind of chemical cleaner. Refer to the **REGULAR CLEANING** section for the proper procedure for cleaning the pads.
3. Re-assemble, refill the reservoir and restart.

LINE CLOGS OR OBSTRUCTIONS (little or no water flow)

Depending on the cleanliness of the water and the amount of dirt, dust, etc. in the air, you may have to clean the PVC pipes from time to time. Your own experience will dictate the frequency.

1. Turn off and unplug the unit.
2. Remove the plastic knob from the threaded rod in the spout.
3. Remove the spout and set it aside.
4. Remove the two screws that hold the top cover on the unit.
5. Remove the top cover and set it aside.
6. Locate the four PVC pipes in the top metal channel. Each PVC pipe is secured to the Y connector by a single screw. Remove this screw from all four PVC pipes.
7. Grip the opposite end of each PVC pipe with pliers and gently twist it out of its Y connector.
8. Remove the plastic mesh socks from the PVC pipes and clean them in warm, soapy water.
9. Direct a jet of water at the series of outlet holes in the PVC pipes to blow them clear.
10. Direct the water nozzle into the end of each pipe and blow them clear. Inspect them for cleanliness and repeat if necessary.
11. Re-install the socks over the PVC pipes, taking care not to bunch them.
12. Replace the PVC pipes, taking care to ensure the water outlet holes are facing inward at 90°. There is a mark on the PVC pipe that indicates the position of the holes.

Be sure you push the PVC pipes fully into the Y connectors so the retaining screws go through the connector and the pipe to hold them in.

ODOR CONTROL

Ensure water source is of good quality and regular maintenance is being conducted. WayCool® Water Conditioner is available from your dealer. See page 15.

LIME OR SCALE BUILDUP

Ensure water source is of good quality and regular maintenance is being conducted. WayCool® Water Conditioner is available from your dealer. See page 15.

SPLATTERING IN FRONT

See **LINE CLOGS OR OBSTRUCTIONS**.

LEAKING FROM THE BOTTOM

Check for cracks in the reservoir. If a crack is found, repair it by using a WayCool® Repair Kit or replace the entire bottom. Order replacement parts from your dealer.

Your WayCool® can be purchased with certain option and/or accessories, and some of these can be retrofitted after the initial purchase. Instructions are included with all equipment purchased separately.

Options available at time of purchase only:

- Oscillating spout

Options and accessories available at time of purchase or after purchase:

- Pneumatic wheels
- Water conditioner and cleaner
- Aluminum grates

PNEUMATIC WHEELS

Pneumatic wheels are available at the time of purchase or as a retrofit kit on a previously purchased WayCool®.

The pneumatic wheel option includes two locking and two non-locking wheels.

Pneumatic wheels are designed to allow for easier rolling on rough or uneven surfaces.



WATER CONDITIONER

WayCool® water conditioner is recommended to control odors found to be present in some water sources.

- Place the tab under the float valve water outlet for fast, effective odor control.
- Place the tab next to the pump for longer lasting odor control.



CLEANER

WayCool® cleaner is recommended to remove scale buildup from the water supply system.

- Follow the instructions on page 13 to clean the unit. Refill with water and add one pint of Cooler Cleaner Treatment to the reservoir. Operate the WayCool® in PUMP ONLY mode for approximately 20 minutes.
- Drain, clean and refill the WayCool® with fresh water. Repeat steps if necessary. Repeat treatment when scale buildup becomes evident.



ALUMINUM GRATES

WayCool® aluminum grates are more durable than the original plastic grates and provide greater protection to the pads.



Options and Accessories cont'd

OSCILLATING SPOUT

The oscillating spout is operated by a four RPM gear motor that delivers 50 in/lbs. in torque. As the gear motor rotates, the spout oscillates in a 110-degree arc, which cools an area of about 9500 square feet.

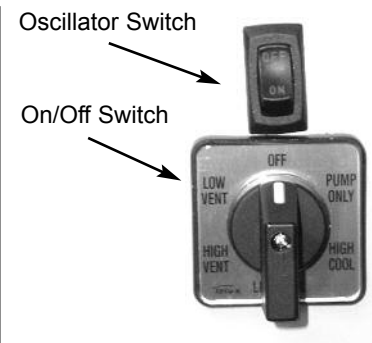
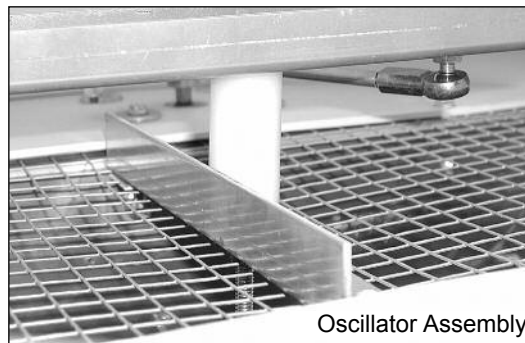

The design of the oscillator requires the blower duct to sit loosely on top of the unit.

Do not place hands or any other object in the spout while unit is operational!
Do not attempt to stop spout from oscillating!

IF UNIT DOES NOT OSCILLATE

1. Ensure the unit is plugged into a standard GFCI-protected 120-volt outlet.
2. Ensure the oscillator switch is in the ON position.
3. Ensure the gear motor is running. To do this, shut off the unit by turning the main switch to the OFF position and leave the rocker switch for the gear motor in the ON position. You should then be able to hear the gear motor.
4. If the motor is running:
 - The spout may be fastened too tight against the top of the WayCool®. The nut above the brace should be loosened to allow 1/16" clearance between the bottom of the spout and the top of the WayCool®.
 - If the spout is not too tight, the linkage may be damaged. Look for visible damage to the linkage rod or the lever. If any of the linkage parts are damaged, they will need to be replaced.
5. If the motor is not running, the motor may have failed or there could be a wiring problem. Contact a licensed electrician. If the motor is determined to have failed, it must be replaced.

IF SPOUT APPEARS TO JUMP WHILE OSCILLATING

1. The spout may be fastened too tight against the top of the WayCool®. The nut above the brace should be loosened to allow 1/16" clearance between the bottom of the spout and the top of the WayCool®.
2. If the spout is not too tight, the linkage may be damaged. Look for visible damage to the linkage rod or the lever. If any of the linkage parts are damaged, they will need to be replaced.

IF UNIT MAKES EXCESSIVE NOISE

1. The spout may be fastened too tight against the top of the WayCool®. The nut above the brace should be loosened to allow 1/16" clearance between the bottom of the spout and the top of the WayCool®.
2. If the spout is not too tight, the linkage may be damaged. Look for visible damage to the linkage rod or the lever. If any of the linkage parts are damaged, they will need to be replaced.
3. A motor bearing may have failed. If the noise is determined to be coming from the motor, the bearing may have failed and the motor may need to be replaced.

IF SPOUT LIFTS UP OUT OF RECESS IN TOP OF UNIT

1. The spout may be too loose. There should be approximately 1/16" clearance between the blower duct and the top of the WayCool®.
2. The linkage may be damaged. Look for visible damage to the linkage rod or the lever. If any of the linkage parts are damaged, they will need to be replaced.



WARNING If the top of the unit is removed for troubleshooting or for any other reason, the wires from the gear motor to the oscillator switch must first be disconnected. This is done by removing the two female disconnects that are attached to the back of the oscillator switch.

**Schaefer Ventilation Equipment, LLC
Schaefer Limited Warranty Policy**

Schaefer Ventilation Equipment, LLC (SVE) provides the following limited warranty from the date of invoice to the initial purchaser of our products or to its customer with a dated proof of purchase:

- I. Two-year coverage (unless otherwise indicated below) applies to all products, components and assemblies provided by SVE that prove to be defective in material or workmanship. Any such defective product will be repaired or replaced at SVE's option, with the defective product or component returned, upon approval, to SVE, F.O.B Sauk Rapids, Minnesota.
- II. This warranty does not cover:
 - a. Failure, damage or malfunction as a result of:
 - i. Improper installation or installation not in accordance with installation instructions.
 - ii. Operating conditions that vary from SVE's operating instructions.
 - iii. Misuse, abuse, negligence, alteration, or accident.
 - iv. Transporting the product.
 - v. Improper operation or lack of appropriate or regular maintenance of the product.
 - b. Loss of time, inconvenience, loss of use of the product or other consequential or incidental damages.
 - c. Parts that need replacement due to normal wear and tear.
 - d. Superficial or cosmetic rust or corrosion.
 - e. Any product whose name plate has been removed.

Products with warranty periods that differ from the standard 2-year warranty are as follows:

- | | |
|---|----------|
| • Poly Housings | 25 years |
| • Fiberglass Housings | 15 years |
| • Low-intensity Tube Heater Exchange Tubes | 5 years |
| • Heavy-Duty Industrial Wash-Down Fans (with VWD motors) | 3 years |
| • K-Series, 2-Stage, Compact and Stainless Steel Tube Heaters | 1 year |
| • Quartz and Zubri Heaters | 1 year |
| • Big Dog™ Fans | 1 year |
| • Shutter Motors and Aluminum Riveted Fan Blades | 1 year |
| • Epoxy Line Wash down fans (with EWD motors) | 1 year |
| • Evaporative Cooling Pads | 180 days |
| • HotZone® Electric Elements | 120 days |
| • Quartz Bulbs | 90 days |
| • Tuff & Gusty Fans | 90 days |
| • Any product or part as noted as an exception to the standard 2-year warranty in the product's operating manual. | |

SVE reserves the right to add or delete products from this exception list at any time.

THERE ARE NO WARRANTIES OF MERCHANTABILITY OR FITNESS OF USE.

SVE reserves the right to change product design and specification without prior notice or liability.

The above constitutes the sole warranty offered by Schaefer Ventilation Equipment, LLC.

Effective March 1, 2010.

All information, illustrations and specifications provided here are based on the latest product information available at the time of printing. Product specifications subject to change.

